

**IVECO**  **-WAY**  
**DRIVE THE NEW WAY**



**IVECO**

Your partner for sustainable transport





**IVECO**



## IVECO S-WAY DRIVE THE NEW WAY

IVECO S-WAY provides a complete transport solution designed to enhance the **driver's life** on board and enable the owners to operate efficiently, profitably and sustainably.

The IVECO S-WAY raises the driver's **working and living** experience to a new level with the cab designed around their needs providing a **spacious** and well laid out environment rich in comfort features and advanced functionalities.

It is set to become a favourite for drivers, and their home from home.

At a time when logistics operators and vehicle owners face increasingly fierce competition, IVECO S-WAY delivers outstanding **fuel efficiency** and **sustainability** together with low Total Cost of Ownership with its advanced technologies and innovative services.

IVECO S-WAY is a **100% connected** truck that ushers in a new era of proactive and **predictive** support. Its advanced connectivity ensures that drivers are always in contact with their fleet manager, their dealer and IVECO's expert specialists, so that they are never alone on the road. It also unlocks a whole range of innovative services tailored to the customer's needs and developed to keep the vehicle on the road, operating at its best and maximising the fleet's efficiency.

With IVECO S-WAY, drivers and owners will DRIVE THE NEW WAY.

---

DRIVE IN STYLE...	06	THE NATURAL WAY	28
...LIVE IN COMFORT	08	MAXIMUM TANK FLEXIBILITY	30
DISTINCTIVE AND FUNCTIONAL	10	EFFICIENTLY POWERFUL	32
PREMIUM DRIVING COMFORT	14	A NEW WORLD OF CONNECTIVITY	36
EVERYTHING IN ITS PLACE	16	PREMIUM TAILORED SERVICES	38
REST, RELAX AND SLEEP WELL	18	ELEMENTS	39
LIT TO PERFECTION	20	IVECO ACCESSORIES	40
THE RIGHT CAB FOR EVERY APPLICATION	22	IVECO SERVICES	41
RIGID VERSATILITY	24	CHOOSE YOUR PREFERRED IVECO S-WAY MODEL	42









IVECO

S-WAY  
L60

IVECO S-WAY



# DRIVE IN STYLE...

Every single detail has been carefully studied to maximise the vehicle's aerodynamic performance: the cab has been streamlined allowing air flow around it to be fully optimised, providing a significant boost to fuel efficiency.

RESHAPED ROOF

TWILIGHT & RAIN SENSORS

12% CX COEFFICIENT IMPROVEMENT

FRONT GRILLE DESIGN

INTEGRATED PARKING COOLER

FULL LED HEADLIGHTS

MULTI-PIECE BUMPER

FOLDABLE STEP





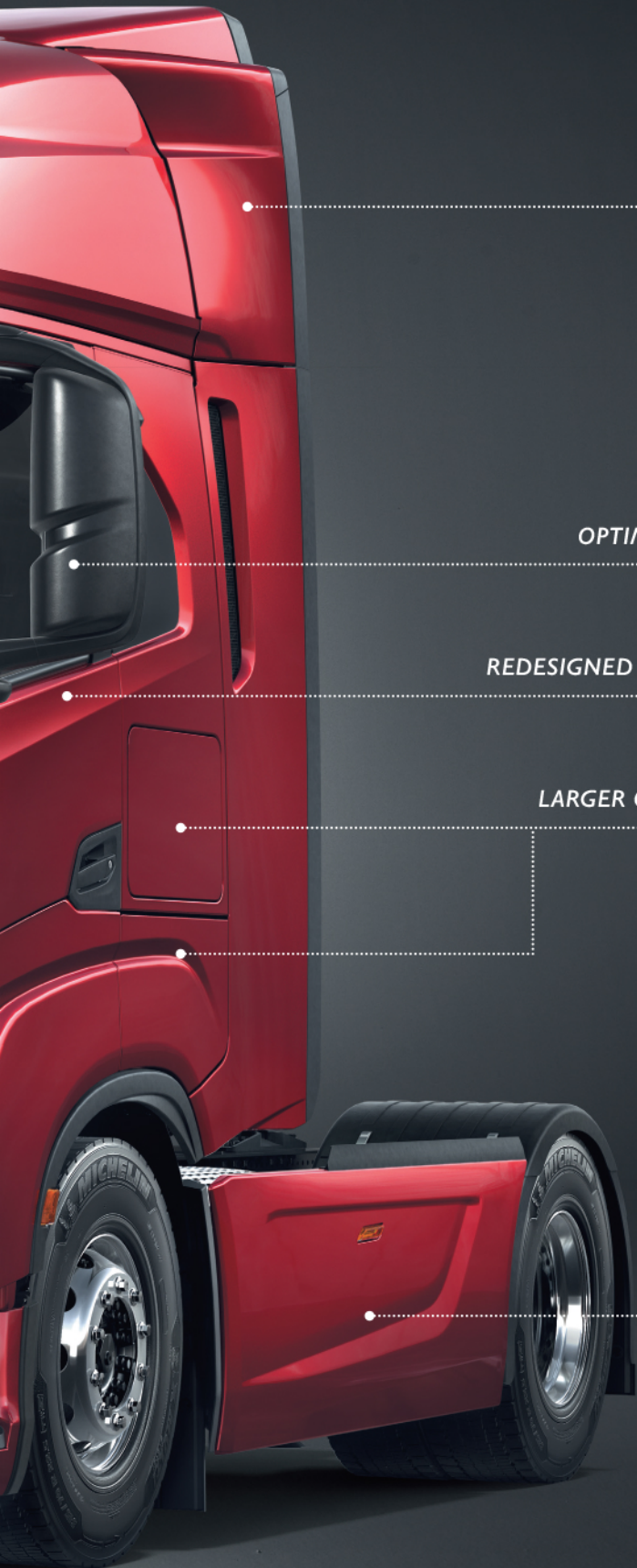

AERODYNAMIC KIT

OPTIMISED MIRROR DESIGN

REDESIGNED AND EXTENDED DOOR

LARGER OUTER COMPARTMENT

SIDE SKIRTS



# ...LIVE IN COMFORT

FULL LED INTERIOR LIGHTING

BIGGER ROOF HATCH

SHAPED HIGH-CAPACITY UPPER SHELF

EASY-TO-REACH  
ROOF POCKETS

CHOICE OF SEAT  
UPHOLSTERY  
AND FEATURES

MORE SPACE  
FOR THE DRIVER

MULTI-FUNCTIONAL  
STEERING WHEEL

ELECTRONIC KEY SLOT  
AND ENGINE START/STOP BUTTON

LOWER CENTRAL CONSOLE  
AND REDESIGNED CENTRAL STACK

COMFORTABLE 2.15M STANDING HEIGHT

SWIVELLING CO-DRIVER SEAT





*CHOICE OF UPPER BUNKS*

*CENTRAL BED MODULE*

*SYMMETRICAL BED ZONE CONCEPT*

*MULTIPLE FRIDGE COMBINATIONS*

*CONVENIENT WALL POCKETS*



# DISTINCTIVE AND FUNCTIONAL

## THE ALL-NEW BUMPER

The redesigned bumper offers a choice of plastic and hybrid solutions to match the requirements of your specific application. The multi-piece bumper will protect you and your vehicle – and save on repair costs as you only need to replace the damaged section.

You can personalize the bumper and side skirts with a choice of colour and material combinations. Rubber extensions on the side skirts contribute to the excellent aerodynamics and efficiency of the design.

### PLASTIC BUMPER



### HYBRID BUMPER



### SIDE SKIRTS







HIGH BEAM

LOW BEAM

FOG LIGHT  
(ALSO CORNERING  
AND BEND  
MANOEUVRES)

GUIDE - DRL  
AND TURN  
INDICATOR

## FULL LED HEADLIGHTS

The new-design full LED headlights will ensure you have all the visibility you need. The twilight sensor on the windscreen automatically turns on the low beam in low-light conditions. Cornering and bend negotiating functions improve the driver's visibility when turning.



The image shows the interior of a truck cab. A black leather seat is the central focus, with a coffee cup on the floor next to it. The background shows the dashboard and steering wheel. The text is overlaid on a dark rectangular area in the middle of the image.

## **A NEW WAY TO RELAX**

Sit back and make yourself at home in the IVECO S-WAY.

Enjoy every moment of the journey, behind the wheel and in the cab, with the fully redesigned interiors.







# PREMIUM DRIVING COMFORT

The entire cab has been created to provide more space and excellent visibility. Every single detail has been carefully studied to meet the driver's expectations on the road.

## LOWER CONSOLE

Handy shelf with bottle and cup holders and background lighting

## INFOTAINMENT

Bring your digital life on board with smartphone mirroring and innovative features

## TWILIGHT & RAIN SENSOR

Automatically turns on the headlights and windscreen wipers

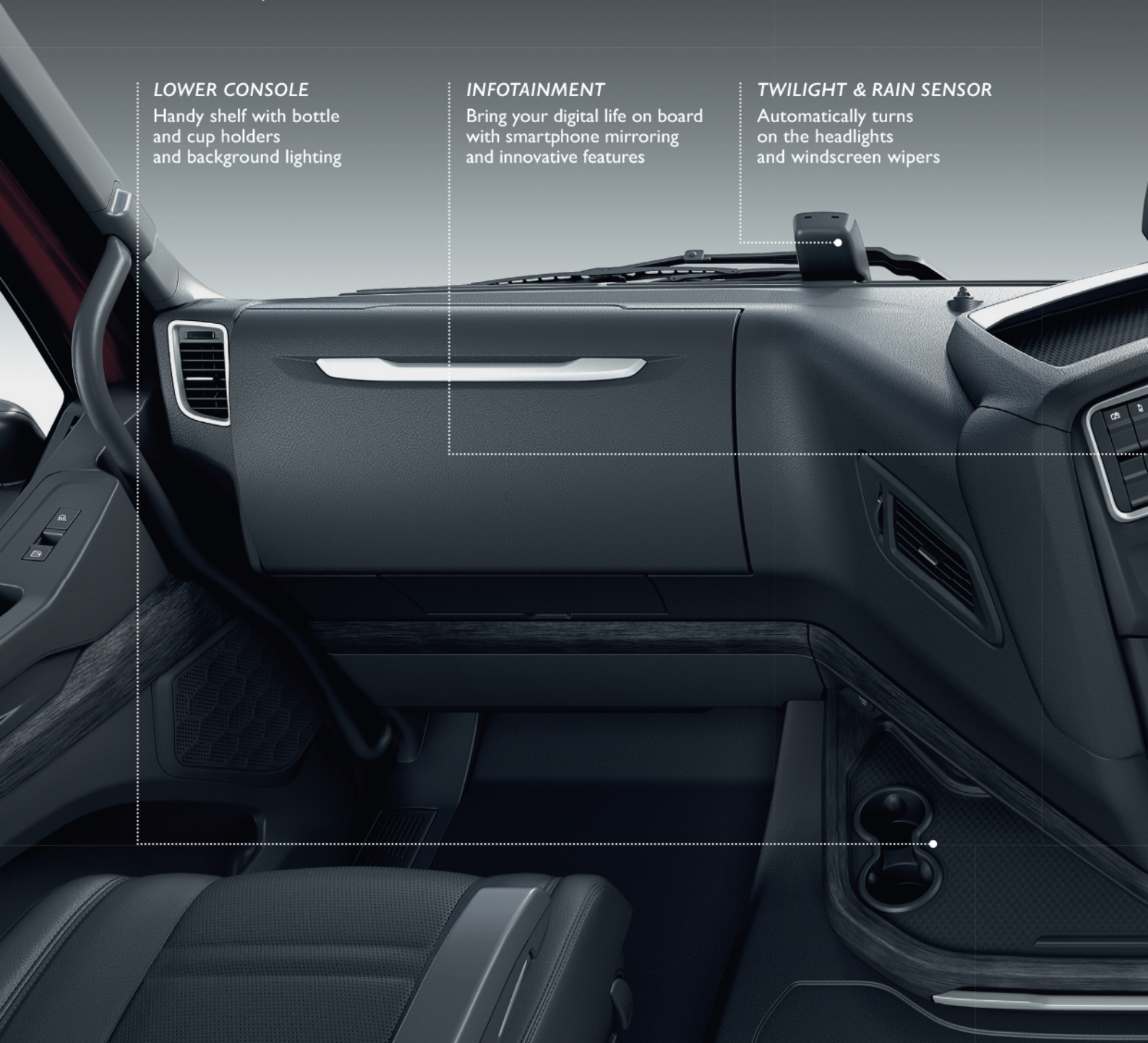

Customise your seats with leather or fabric upholstery and enjoy the luxurious comfort of the cushions.



**KEY LOCK AREA**

Turn the engine on and off by simply pushing the Start/Stop button

**INTEGRATED HVAC SYSTEM**

Heating, Ventilation and Air Conditioning

**STEERING WHEEL**

All the vehicle's key functions at your fingertips



Choose from the soft touch or leather steering wheel, both available in the classic shape or with the distinctive flat base.



# EVERYTHING IN ITS PLACE

The spacious new cab offers all the storage you need, with well laid-out capacious compartments. The shaped upper shelf has a massive capacity of 250 litres.



The outer compartments offer a massive storage capacity of up to 380 litres.





A folding table is integrated in the dashboard on the co-driver's side.



Wide selection of refrigerators with capacities up to 100 litres and also available with a freezer.



The lower console can hold a thick A4 folder.



The new open glove compartment includes a 1.5-litre bottle holder.



# REST, RELAX AND SLEEP WELL



The symmetrical layout of the night area has been designed so that you can enjoy a good night's rest in great comfort. The one-piece lower bunk offers a choice of soft or hard mattress.



You can sleep safe with the central locking system integrated with the night-time safety lock.



The rotary switch controls the light selection and dimming.





Choose from the Smart or Comfort upper bunk, which can be used as a luggage compartment or a passenger bed.



Two USB ports are located on the upper pockets of each wall.



You can control all the functions you need, such as lighting, heating, radio or doors, from the bed module and on the MYIVECO EasyWay App.



# LIT TO PERFECTION

The IVECO S-WAY is 100% full LED - inside and out, including the clearance lights. The new LED lights provide the perfect illumination inside the cab and on the road for safe night-time driving.









# THE RIGHT CAB FOR EVERY APPLICATION



The IVECO S-WAY cab line up offers a choice of cabs to match your business: the **AS** sleeper cab, the **AT** sleeper cab with low or medium roof, and the **AD** short cab with low roof.

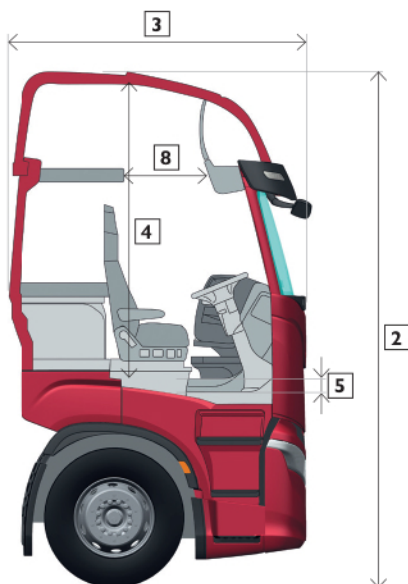

## KEY

- 1 WIDTH
- 2 OVERALL HEIGHT
- 3 LENGTH
- 4 FLOOR TO ROOF CAB CENTRE
- 5 TUNNEL HEIGHT
- 6 PASSENGER USABLE SPACE
- 7 LOWER USABLE SPACE
- 8 UPPER USABLE SPACE

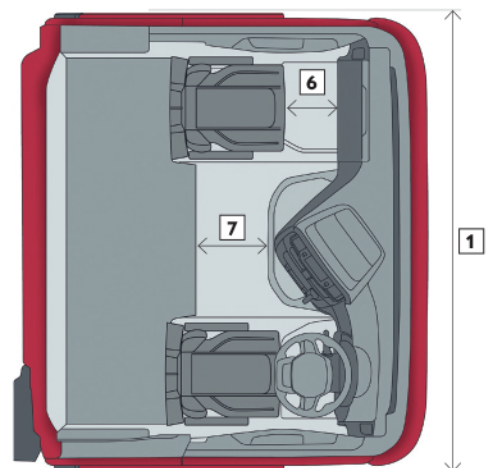





		1	2	3	4	5	6	7	8	9	10
<b>AS</b>	<b>Roof</b>	<b>Width (mm)</b>	<b>Overall Height (mm)</b>	<b>Length (mm)</b>	<b>Floor to Roof Cab Centre (mm)</b>	<b>Tunnel Height (mm)</b>	<b>Passenger Usable Space (mm)</b>	<b>Lower Usable Space (mm)</b>	<b>Upper Usable Space (mm)</b>	<b>Bunk <sup>(2)</sup></b>	<b>Access steps</b>
	High	2,500	3,800 <sup>(1)</sup>	2,250	2,150	95	430	500	785	1 (2)	3
Low	2,500	3,300 <sup>(1)</sup>	2,250	1,700	95	430	500	-	1		
<b>AT</b>	Medium	2,300	3,550 <sup>(1)</sup>	2,150	1,850	340	370	470	480	1 (2)	3
	Low	2,300	2,900 <sup>(1)</sup>	2,150	1,250	340	370	470	-	1	
<b>AD</b>	Low	2,300	2,550 <sup>(1)</sup>	1,700	1,250	340	370	-	-	0	3

Dimensions can vary according to the model.

**NOTE**

<sup>(1)</sup> Approximate measures; may change based on suspensions, assembly variables and approximations.

<sup>(2)</sup> Upper bed as option.

**AS Cab**

Lower bunk length 2,100mm, width 800mm (700mm rear seats).  
Upper bunk length 2,040mm, width 600mm (700mm with Comfort Bunk).

**AT Cab**

Lower bunk length 1,950mm, width 540mm.  
Upper bunk length 1,850mm, width 680mm.



# RIGID VERSATILITY

The IVECO S-WAY offers a full range of rigids, in diesel and Natural Power versions, suitable for all jobs – from municipal applications and deliveries to demountable bodies. The robust and durable chassis makes it a favourite of bodybuilders for the ease and wide variety of possible builds.















## **A NEW WAY TO MOVE**

Lower costs for you, lower impact on the environment.

IVECO is the market leader in sustainable transport with a full new line-up of Natural Power engines.

Performance and sustainability together on the road.



# THE NATURAL WAY

The new IVECO S-WAY cab, teamed up with the most mature natural gas technology on the market, is the undisputed sustainable leader for long-haul transport.

## ECONOMIC SUSTAINABILITY

The natural way gives you the competitive advantage with a truly 'green' and profitable solution for long-distance transport with best-in-class Total Cost of Ownership.







### EFFICIENT ENVIRONMENTAL SUSTAINABILITY

IVECO S-WAY NP maximises the advantages of the most environmentally-friendly fuel to improve air quality, mitigate climate change and contribute to a quieter environment with just 71dB(A) Piek Quiet Truck when running in Silent Mode – ideal for night-time deliveries.

### NATURALLY LONG-DISTANCE

IVECO S-WAY NP is the first gas-fuelled truck on the market specifically designed for international long-haul transport with an exceptional range of up to 1,600km (in 4x2 configuration).



for NO<sub>2</sub>



for particulate matter



for CO<sub>2</sub> with biomethane



### RIGID, THE NATURAL WAY

The IVECO S-WAY NP 2- and 3-axle rigid has been designed to provide a sustainable transport solution for urban and regional distribution. Its green and quiet operation opens access to city centres, densely populated areas and highly regulated low-emissions zones.

### EXPERT SUPPORT FROM THE TECHNOLOGY LEADER

IVECO has pioneered natural gas technology for more than 20 years, developing a widespread network of IVECO service points specialising in LNG and CNG technology, which provide support across Europe.



# MAXIMUM TANK FLEXIBILITY

## A COMBINATION FOR EVERY APPLICATION

You can choose from a wide offering of tanks of varying types, shapes and sizes which can be combined to meet the specific requirements of your business.



LNG tank on the right side, available in combination with, on the left side:

- LNG
- CNG
- Free

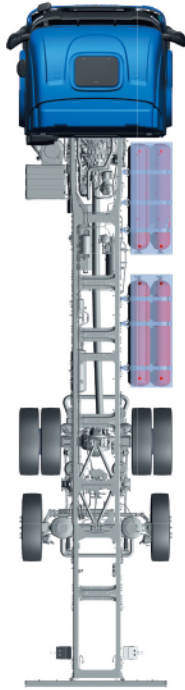

CNG tanks on the right side, available in combination with, on the left side:

- LNG
- CNG
- Free



CNG tanks behind the cab, available in combination with:

- Left side CNG; right side CNG
- Left side CNG; right side free
- Left side free; right side CNG



LNG tank on the left side, available in combination with LNG tank on the right side.

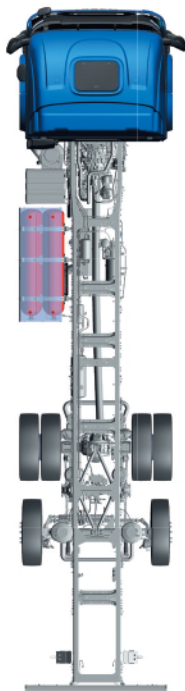

CNG tanks on the left side, available in combination with CNG or LNG tanks on the right side.

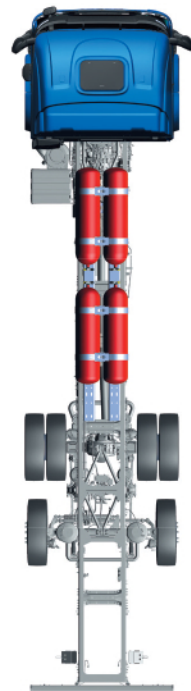

CNG tanks on the chassis, available in combination with:

- Right side CNG; left side free
- Right side free, left side CNG





## BEST-IN-CLASS RANGE

LNG tanks for standard tractors come in a number of sizes to free up the space you need on the chassis for your application.



LNG - up to 1,600km



LNG - up to 1,400km



LNG - up to 1,150km



LNG - up to 800km



# EFFICIENTLY POWERFUL

## HIGH-EFFICIENCY ENGINES

The IVECO S-WAY offers a wide choice of Euro VI/d diesel and natural gas engines to suit all applications.

The diesel engines, with 3 displacements and power ratings ranging from 330 to 570, deliver class-leading power. They are also available in natural gas versions that offer clean running and quiet operation.

### DIESEL ENGINE LINE-UP

ENGINE	DISPLACEMENT (Litres)	POWER hp @ rpm	TORQUE Nm @ rpm	AFTER TREATMENT SYSTEM	EMISSION STANDARD
CURSOR 9	8.7	330 @ 1,655 – 2,200	1,400 @ 1,100 – 1,655	HI-SCR	Euro VI/d
		360 @ 1,530 – 2,200	1,650 @ 1,200 – 1,530		
		400 @ 1,655 – 2,200	1,700 @ 1,200 – 1,655		
CURSOR 11	11.1	420 @ 1,475 – 1,900	2,000 @ 870 – 1,475	HI-SCR	Euro VI/d
		460 @ 1,500 – 1,900	2,150 @ 925 – 1,500		
		480 @ 1,465 – 1,900	2,300 @ 970 – 1,465		
CURSOR 13	12.9	510 @ 1,560 – 1,900	2,300 @ 900 – 1,560	HI-SCR	Euro VI/d
		570 @ 1,605 – 1,900	2,500 @ 1,000 – 1,605		

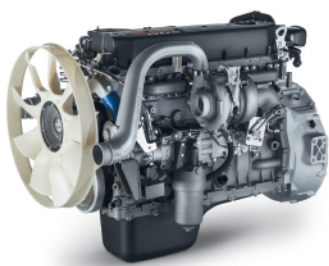

Cursor 9



Cursor 11

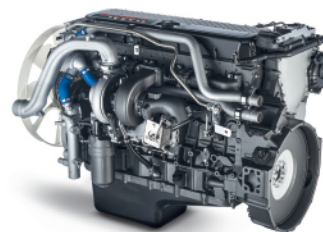

Cursor 13

### NATURAL POWER ENGINE LINE-UP

ENGINE	DISPLACEMENT (Litres)	POWER hp @ rpm	TORQUE Nm @ rpm	AFTER TREATMENT SYSTEM	EMISSION STANDARD
CURSOR 9 NP	8.7	340/250 @ 2,000	1,500 @ 1,100 – 1,600	3-way Catalyst	Euro VI/d
		400/294 @ 2,000	1,700 @ 1,200 – 1,575		
CURSOR 13 NP	12.9	460/338 @ 1,900	2,000 @ 1,100 – 1,600	3-way Catalyst	Euro VI/d



Cursor 9 NP



Cursor 13 NP



## FUEL-SAVING DEVICES

- The Anti-Idling feature avoids long periods of idling, automatically shutting off the engine.
- Smart EGR increases combustion efficiency by optimising injection timing, and reducing consumption
- Smart Engine Auxiliaries prevent energy waste when their operation is not necessary:
  - Air Clutch Compressor
  - Smart Alternator
  - Variable Steering Pump



## IVECO HI-CRUISE

The IVECO HI-CRUISE GPS predictive driving system integrates driving assistance functions such as eco-roll, predictive gear shifting and predictive cruise control using state-of-the-art GPS mapping technology.

## HIGH-EFFICIENCY TRANSMISSION

The 12-speed HI-TRONIX automated transmission with electronic clutch offers the most advanced technology in its category, best-in-class torque-to-weight ratio and long transmission oil change intervals.





## **A NEW WAY TO CONNECT**

You will never feel alone on board  
the IVECO S-WAY.

The most advanced connectivity puts you  
in full control of the truck, and always  
in communication with your fleet manager  
if anything comes up.







# A NEW WORLD OF CONNECTIVITY

Connectivity on the new IVECO S-WAY has been designed to help the driver operate effortlessly and efficiently, and to support the fleet manager by optimising the vehicle's uptime, fuel efficiency and Total Cost of Ownership.



## OPERATE THE EASY WAY WITH CONNECTIVITY ON BOARD

You can take your digital life on board with Apple Car Play, which enables you to mirror your mobile device on the new infotainment system and use all its functionalities in full safety while driving.

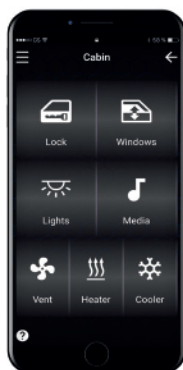

Cab Control



Driving Assist

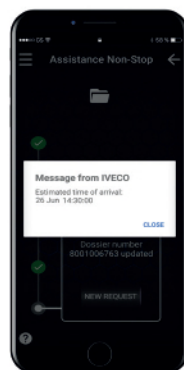

IVECO Assistance Non-Stop

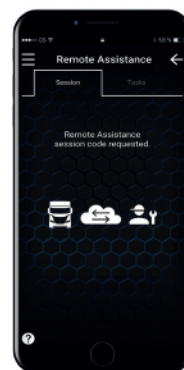

Remote Assistance Service

## MYIVECO EASY WAY – THE IVECO S-WAY DRIVER'S APP

The new app, designed to make your life as an IVECO S-WAY driver easy, enables you to control on your mobile device all the cab and vehicle management functionalities. You can also use it to activate the IVECO Assistance Non-Stop service, access remote diagnostics data and view the vehicle's Driving Style Evaluation tool. Easy.



## OPTIMISE YOUR FLEET WITH MY IVECO WAY SOLUTIONS

The new standard Connectivity Box puts your vehicle in direct communication with the IVECO team of experts who receive data in real time and monitor it round the clock to provide proactive support with the new MYIVECO WAY Solutions.

### SMART CONNECTIVITY PACK

The on-board IVECO DRIVING STYLE EVALUATION (DSE) generates weekly reports on the vehicle's and driver's performance with tips on how you can improve the driving style for fuel and vehicle optimisation.

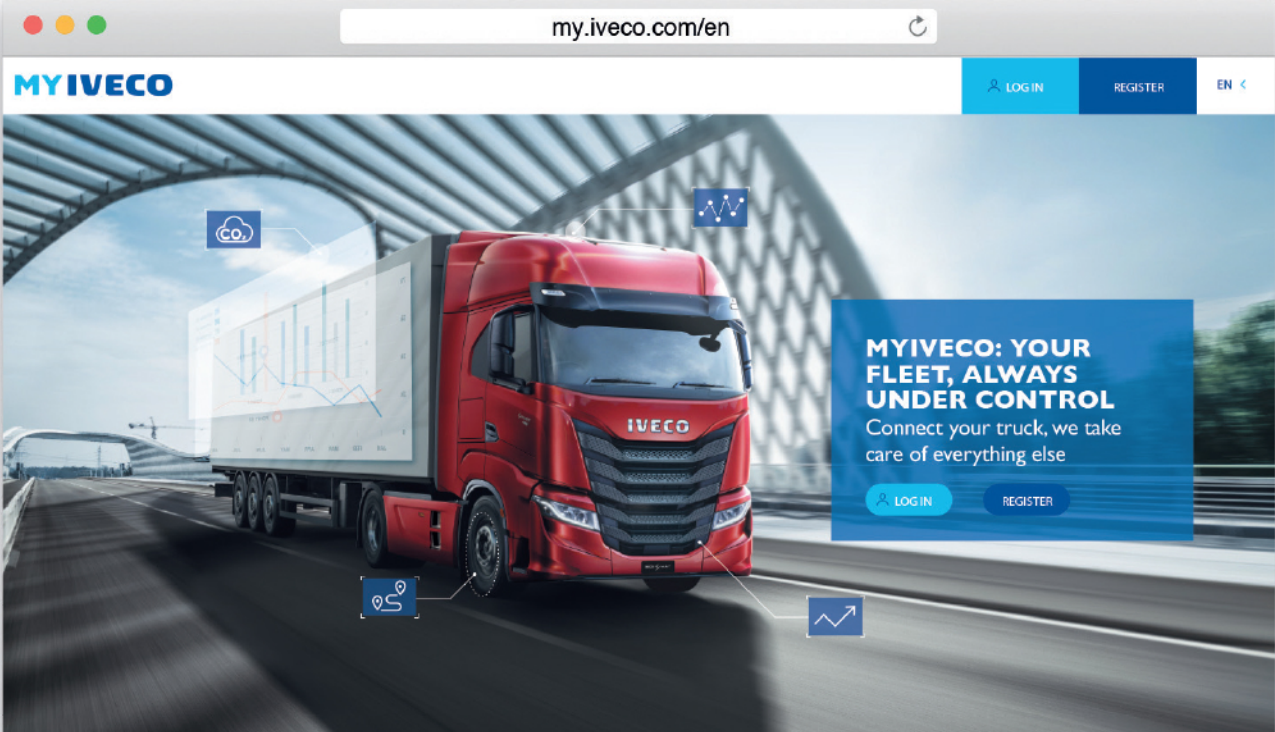

The screenshot shows the my.iveco.com/en website. At the top, there is a navigation bar with the MYIVECO logo on the left and 'LOG IN', 'REGISTER', and 'EN <' on the right. The main content area features a large image of a red IVECO truck driving on a road. Overlaid on the truck are several data visualization icons: a CO2 icon, a line graph, a location pin, and another line graph. To the right of the truck, there is a blue call-to-action box with the text 'MYIVECO: YOUR FLEET, ALWAYS UNDER CONTROL' and 'Connect your truck, we take care of everything else'. Below this text are 'LOG IN' and 'REGISTER' buttons. At the bottom of the screenshot, there is a white box with the text 'Check your fleet efficiency, it's never been so easy'.

### MYIVECO – YOUR PORTAL AND APP

The MYIVECO portal and app enable you to monitor your vehicle's fuel consumption and your driver's driving style in real time, so you can identify ways to optimise your fleet's performance. You can also plan and book service appointments efficiently to maximise uptime.

### MORE TIME ON THE ROAD

The IVECO S-WAY'S connectivity will help maximise your vehicle's uptime and productivity through a proactive approach with the Remote Assistance Service tool for remote diagnostics, teleservices and over-the-air software updates. It also provides a proactive service based on fault code alerts that trigger Control Room action and status of health monitoring of main components that will alert you when you need to plan a service intervention, avoiding unplanned stoppages.





# PREMIUM TAILORED SERVICES

IVECO S-WAY connectivity also unlocks a new modular service offering to help you optimise your fleet's performance and efficiency.

## FUEL ADVISORS AND DRIVER TRAINING PROGRAMMES ON THE MAIN EUROPEAN ROUTES



### TCO Advising

A dedicated IVECO team of Fuel Advisors



### TCO Driving

ECO-Driving; Driver Training Programmes



### PROFESSIONAL FUEL ADVISING SERVICE

This new advanced service provides detailed analysis of your vehicle's fuel consumption and suggestions from IVECO's experts on how you can improve its fuel economy based on comparisons with mission-based ideal consumption estimates. It also provides monitoring with alerts on events that may affect the vehicle's fuel efficiency, such as tyre pressure or fuel and air filter clogging, also maximising your use of the truck.

### FLEXIBLE MAINTENANCE PLANNING

The real-time data provided by your vehicle through its connectivity enables you to plan repair and maintenance interventions efficiently to reduce unplanned stops and maximise the life of the monitored components based on the real usage of the vehicle.

### UPTIME MONITORING

In addition to the proactive support provided by MYIVECO WAY Solutions, this premium service prioritises the action required and we will follow up progress to get your vehicle back on the road as quickly as possible.



### PROFESSIONAL FLEET MANAGEMENT SOLUTIONS

This advanced logistics and despatching service, offered in partnership with Verizon and Astrata, enables you to track and trace your vehicle with a Geofencing function and provides a Remote Tacho Download Service (RTDS).

### MYIVECO WEB API

The MYIVECO Web Application Programming Interface (API) seamlessly interacts with your fleet management system to provide all your vehicle's data directly in your own unique system.



# ELEMENTS

## PICK THE SERVICES THAT PERFECTLY MATCH YOUR BUSINESS

The IVECO S-WAY offers an extensive range of services that can be tailored to your precise requirements to keep your vehicle running in top form and your business operating with a healthy bottom line.

The IVECO S-WAY introduces an entirely new level of customisation through connectivity. The real-time vehicle data it provides enables us to offer you **bespoke maintenance plans** based on the real use of your IVECO S-WAY – a perfect match to your business.

Alternatively, our **Elements** range offers the extreme **flexibility** that enables you to choose the combination of Planned Maintenance and Extended Warranty services for your business, and further enrich your package with the Additional Coverage elements.



<b>MAINTENANCE</b> 	<b>DRIVE LINE</b> 	<b>EXTRA DRIVE LINE</b> 	<b>WEAR</b> 	<b>LEGAL INSPECTION</b> 
<ul style="list-style-type: none"> <li>- Maintenance</li> <li>- Lubrication</li> <li>- Oil and fluid changes according to the maintenance and repair handbook</li> </ul>	<ul style="list-style-type: none"> <li>- Engine</li> <li>- Fuel injection</li> <li>- Gearbox</li> <li>- Propeller shaft and axle repairs</li> </ul>	<ul style="list-style-type: none"> <li>- Components not already covered by the drive line element e.g. Electrical System</li> </ul>	<ul style="list-style-type: none"> <li>- Clutch</li> <li>- Brake pads</li> <li>- Brake discs</li> <li>- Brake drums</li> <li>- Brake linings for drum brakes</li> </ul>	<ul style="list-style-type: none"> <li>- Statutory legal requirements for operators licence e.g. Ministry inspection, MOT's</li> </ul>

The major "elements" making up the offer (Maintenance, Drive Line, Extra Drive Line, Wear, Legal Inspection) can be combined in order to create the contract that perfectly suits your business. The table below summarises all the possible combinations:

### PLANNED MAINTENANCE CONTRACTS

	MAINTENANCE 	DRIVE LINE 	EXTRA DRIVE LINE 	WEAR 	LEGAL INSPECTION 
<b>3XL LIFE</b>	•	•	•	•	
<b>2XL LIFE</b>	•	•	•		
<b>XL LIFE</b>	•	•		•	
<b>L LIFE</b>	•	•			
<b>M LIFE</b>	•			•	
<b>S LIFE</b>	•				
<b>XS LIFE</b>					•

### EXTENDED WARRANTY

	DRIVE LINE 	EXTRA DRIVE LINE 
<b>XTRA XTENDED LIFE</b>	•	•
<b>XTENDED LIFE</b>	•	

For inclusions / exclusions please refer to contractual documents relevant to your Market.



The truck is much more than a vehicle: it is where thousands of people live and work every day. That's why IVECO Accessories have created a range of tailor-made products to satisfy the driver's needs, improve their performance, enhance the vehicle's style and comfort, and introduce new technologies on board.



## EXPRESS YOUR PERSONALITY

New IVECO S-WAY can be made even more exclusive with the new styling kit, mirror covers and chromed details – like the new lightbar and the chromed styling kit of the vehicle.



## TECHNOLOGY ON BOARD

Bring the most updated technologies on board and enjoy your comfort. The new subwoofer system enhances sound quality and the new 22" TV allows you to relax at the end of a day behind the wheel. Install the new tailor-made cradle for smartphone and tablet on the dashboard: your device will be within easy reach and you will always be connected.



## TECHNOLOGY TO FEEL AT HOME

Feel at home wherever you are with IVECO. The new USB LED reading light with flexible arm will direct extra light where you need it. You can comfortably cook in the cab during a stop using the microwave oven, cleverly positioned on the passenger upper shelf.

The IVECO Accessories range is displayed in full in the accessories catalogue – and online at <http://application.cnh-parts-service.eu/iveco.php>



All customisation opportunities at hand with the "IVECO Accessories" free app.

The free app can be downloaded from App Store to get exclusive access to extra images and information.





# IVECO SERVICES

## IVECO CAPITAL

IVECO CAPITAL is the captive financial services brand of IVECO, and offers a full range of financing and leasing for commercial vehicles, including the financing of extended warranty product.\*

The finance profiles can be tailored to meet the needs of the customer and apply to new, used and conversions.

For more information, please contact your IVECO dealer.



\*Extended warranty can only be included when financed at the same time as the vehicle.

**IVECO**  
**0080048326000**  
Assistance Non-Stop



IVECO Assistance Non-Stop is just a phone call away 24 hours a day, 7 days a week to keep your IVECO S-WAY and your business running.

IVECO Non-Stop is the original IVECO smartphone application that you can use to communicate with IVECO if your vehicle breaks down. Just insert your vehicle information (VIN and registration plate) and with a simple push of a button you can send a request for assistance to the IVECO Customer Centre. We will take care of your request immediately, activate the nearest workshop and follow up on the vehicle's repair. Through the app you can receive updates on the progress of your vehicle's assistance.



## IVECO | Genuine Parts HIGH PERFORMANCE







IVECO Genuine Parts represent the best guarantee of **safeguarding the value of your New IVECO S-WAY** over time, **protecting it from unplanned downtime**, ensuring safety for people and goods. IVECO also offers the widest range of new and remanufactured components, servicing kits and telematics solutions, suitable for every stage of the New IVECO S-WAY's lifecycle. IVECO operates a network of 7 parts depots across Europe, covering over 335,000 sqm, managing 400,000 part numbers and guaranteeing 24/7 parts delivery.



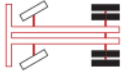
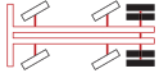
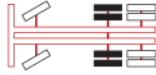





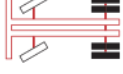
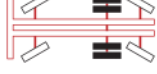
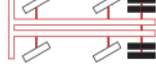

IVECO is a brand of CNH Industrial N.V., a global leader in the capital goods sector that, through its various businesses, designs, produces and sells agricultural and construction equipment, trucks, commercial vehicles, buses and specialty vehicles, in addition to a broad portfolio of powertrain applications. It also distributes high performance genuine parts for all CNH Industrial Commercial Brands.











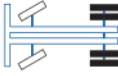
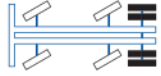

# CHOOSE YOUR PREFERRED IVECO S-WAY MODEL

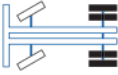
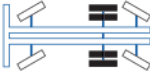
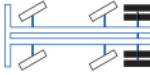
IVECO S-WAY		ARTIC					
		4x2		6x2C		6x2P (Twin)	
							
CAB ROOF	AS	-		-			
	AT		-		-	-	
	AD		-	-	-	-	
ENGINE / GEARBOX	Cursor 9	Automated / Manual	-	-	-	-	
	Cursor 11	Automated / Manual	Automated	Automated	Automated	Automated	
	Cursor 13	-	Automated	-	Automated	Automated	
REAR AXLE SUSPENSION	SR	Air / Full Air		Air / Full Air		Air	
WHEELBASES (mm)		3,650 - 3,800		3,800 - 4,000		3,200 - 3,800	

IVECO S-WAY		RIGID					
		4x2		6x2P		6x2C	
							
CAB ROOF	AS	-		-		-	
	AT		-		-		
	AD		-		-		
ENGINE / GEARBOX	Cursor 9	Automated / Manual / Automatic	-	Automated / Manual / Automatic	-	Automated / Manual / Automatic	
	Cursor 11	Automated / Manual	Automated	Automated / Manual	Automated	-	
	Cursor 13	-	Automated	-	Automated	-	
REAR AXLE SUSPENSION	SR	Mechanical Air / Full Air		Air / Full Air		Air / Full Air	
WHEELBASES (mm)		3,800 ÷ 6,700		3,120 ÷ 6,700		4,200 - 4,500	



IVECO S-WAY NP		ARTIC	
		4x2	6x2C
			
CAB ROOF	AS		
	AT	-	-
	AD	-	-
ENGINE / GEARBOX	Cursor 9 NP	-	-
	Cursor 13 NP	Automated	Automated
FUEL SYSTEM	CNG	Up to 650km	-
	CLNG	Up to 1,080km	-
	LNG	Up to 1,600km for T/P Up to 1,150km for LT	Up to 750km
REAR AXLE SUSPENSION	SR	Air / Full Air	Air / Full Air
WHEELBASES (mm)		3,800	4,000

IVECO S-WAY NP		RIGID				
		4x2	6x2P		6x2C	
						
CAB ROOF	AS	-		-		-
	AT		-		-	-
	AD		-		-	
ENGINE / GEARBOX	Cursor 9	Automated / Automatic	-	Automated / Automatic	-	Automatic
	Cursor 13	-	Automated	-	Automated	-
FUEL SYSTEM	CNG	Up to 1,000km				150 ÷ 400km
	CLNG	Up to 1,100km				-
	LNG	Up to 1,600km				-
REAR AXLE SUSPENSION	SR	Air / Full Air		Air / Full Air		Air / Full Air
WHEELBASES (mm)		3,800 ÷ 6,300	/FP CM: 5,700	/P: 3,120 ÷ 6,050 /FP D: 3,800 ÷ 6,050	/P- /FP: 3,120 ÷ 6,050 /FP CM: 4,800 ÷ 6,050	5,000





**IVECO**  
Your partner for sustainable transport

